



Quotation of Portable Machine Tools

Product Description

Our comprehensive portable maintenance line includes a full range of heavy machinery repair tools. For bore repair, we offer portable boring machine, portable line boring machine, mobile line boring machine portable boring machine, and the XDT50 High-speed Welding All-in-one Machine—a versatile portable line boring machine and bore welding solution, with the automatic portable line boring and welding machine model available as portable line boring machine for sale.

For flange and shaft work, our Manual Flange Processing Machine (also a flange facing machine and portable flange facing machine) is listed as flange-facing-machine-for-sale, alongside the Automatic Soldering Machine and automatic wire soldering machine. We also provide Portable CNC Thread Milling Machine, Portable Shaft End Machine (functioning as a portable shaft lathe and portable shaft turning lathe), plus portable lathe machine and portable lathe machines tool for on-site turning.

For assembly tasks, our sleeve pressing machine (manual/electric) and Portable Chain Press (also a track pin press) complete the set, enabling efficient disassembly and reassembly of engineering machinery components.





ZHENGZHOU LERFORD MACHINERY EQUIPMENT CO.,LTD

Tel: 86 371 55960109
Mobile:+8615838007835
E-mail:susan@pelletmilling.com

Fax: 86 371 55960109
Website:www.lffoodmachine.com
Skype:annieshuang1129

Boring Machine

Our XDT series includes XDT40/XDT60/XDT90/XDT110 portable boring machine models, covering compact to heavy-duty on-site repair needs. The XDT50 series features a High-speed Welding All-in-one Machine and automatic portable line boring and welding machine, acting as a versatile portable line boring machine and bore welding solution. All models are robust mobile line boring machine portable boring machine options, ideal for excavator and heavy machinery bore repair, available as portable line boring machine for sale with precise machining and field operation convenience.

BORING MACHINE

XDT40-Portable Boring Machine:



XDT60-Portable Hydraulic Boring Machine:



XDT50-High-Speed Welding All-in-one Machine (Standard version) :



XDT60-Technical Specifications Of Turbine Worm Boring Machine:



XDT50-High-Speed Boring And Welding Machine (CNC) :



XDT90-Portable Boring Machine:



XDT90-Technical Specifications Of Turbine Worm Boring Machine:



XDT60-Portable Boring Machine:



XDT110-Portable Boring Machine:



Finished product

Our portable boring machine and integrated welding machine deliver exceptional on-site repair results for worn

**Quality, price, time and service is the tenet of our business.
Credit, reposal, negotiation and cooperation is our standard.**



ZHENGZHOU LERFORD MACHINERY EQUIPMENT CO.,LTD

Tel: 86 371 55960109

Fax: 86 371 55960109

Mobile:+8615838007835

Website:www.lffoodmachine.com

E-mail:susan@pelletmilling.com

Skype:annieshuang1129

flanges and bores:

1.Boring Machine: Transforms rough, corroded bores into precision-machined, smooth surfaces, restoring dimensional accuracy without disassembly.

2.Integrated Welding Machine: Repairs rusted, damaged flanges by first filling worn areas, then machining to a like-new finish—ideal for heavy machinery and industrial components.

Both machines ensure reliable, high-quality restoration, making them essential tools for construction, mining, and oil & gas equipment maintenance.

Finished Product

Boring Machine:



Before



After

Integrated Welding Machine



Before



After

Product Technical Information

Quality, price, time and service is the tenet of our business.
Credit, reposal, negotiation and cooperation is our standard.



ZHENGZHOU LERFORD MACHINERY EQUIPMENT CO.,LTD

Tel: 86 371 55960109

Fax: 86 371 55960109

Mobile:+8615838007835

Website:www.lffoodmachine.com

E-mail:susan@pelletmilling.com

Skype:annieshuang1129

Portable boring machine (XDT40/XDT50):

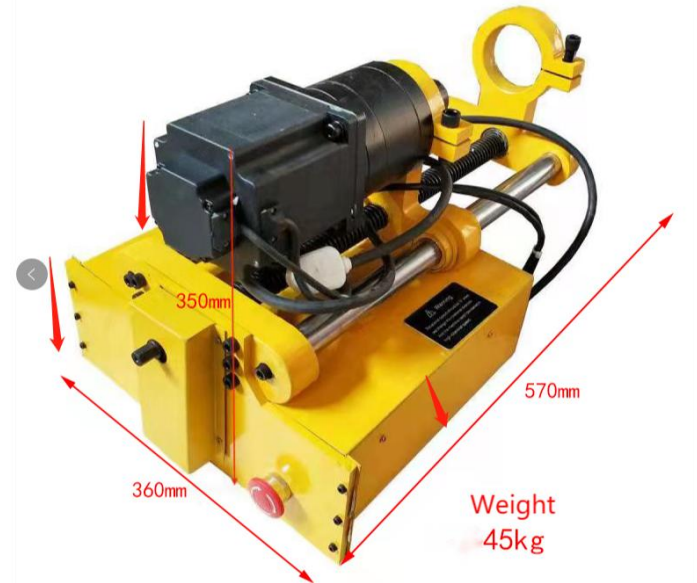

Model	Material	Capacity	Power	Volt age	Size	Packing Size	Weight	Price
XDT40	Carton Steel	380mm	1.5	220v	730*430*500mm +1550*90*80mm	730*430*500mm+ 1550*90*80mm	89.5	\$ 1860
XDT50	Carton Steel	380mm	1.5	220v	730*430*500mm +1550*90*80mm	730*430*500mm+ 1550*90*80mm	101	\$ 1990

Accessories of portable boring machine (XDT40/XDT50)

Specifications Accessories	XDT40	XDT50
Boring bar	1.5 m*1	
Auxiliary knife rest	1	
Knife handle	1	
Blade	1	
Centering taper sleeve	4	
Bracket	2	
Support bolt	8	
Tool	1	

High-Speed Welding All-in-one Machine (Standard version) -(XDT50):

**Quality, price, time and service is the tenet of our business.
Credit, reposal, negotiation and cooperation is our standard.**



ZHENGZHOU LERFORD MACHINERY EQUIPMENT CO.,LTD

Tel: 86 371 55960109

Fax: 86 371 55960109

Mobile:+8615838007835

Website:www.lffoodmachine.com

E-mail:susan@pelletmilling.com

Skype:annieshuang1129



Model	Material	Capacity	Power	Voltage	Size	Packing Size	Weight	Price
XDT50 (stand ard)	Carton Steel	260mm	3	220	730*430*500mm +1550*90*80mm	730*430*500mm +1550*90*80mm	136.5	\$ 2990
XDT50 (Turbo drive)	Carton Steel	260mm	3	220	730*430*500mm +1550*90*80mm	730*430*500mm +1550*90*80mm	136.5	\$ 3150
XDT60 (stand ard)	Carton Steel	380mm	2	220	730*430*500mm +1550*90*80mm	730*430*500mm +1550*90*80mm	110.5	\$ 7960

Accessories of high-speed boring and welding machine (XDT50)

Accessories		Specifications
Boring and welding head	Boring bar	φ 50 mm *1
	Knife shaft	1.5 m *1/0.6 m*1
Supporting base		2
Tile support		1
Lock		1
Support bolt		8
Centering sleeve		4
Knife rest		1
Top plate		1
Oil can		1
Adjustable wrench		1
Socket screw hexagon wrench		1
Machine clamp blade		10*1
Machine clamp handle		φ 16 mm/ φ 12 mm
Top knife sleeve		1
Spare small screws		1

Quality, price, time and service is the tenet of our business.

Credit, reposal, negotiation and cooperation is our standard.



ZHENGZHOU LERFORD MACHINERY EQUIPMENT CO.,LTD

Tel: 86 371 55960109

Fax: 86 371 55960109

Mobile:+8615838007835

Website:www.lffoodmachine.com

E-mail:susan@pelletmilling.com

Skype:annieshuang1129

Accessories	Specifications
Wire feeding tube	2
Connecting wire for master welder	1
Welding torch rod	1.2 m*1/0.3 m*1
Centering sleeve	1
Shroud	3
Nozzle	3

High-speed boring and welding machine (XDT50)-CNC:



Model	Material	Capacity	Power	Voltage	Size	Packing Size	Weight	Price
XDT50 (Gear drive)	Carbon Steel	260mm	3	220	730*430*500mm+ 1550*90*80mm	730*430*500mm+ 1550*90*80mm	136.5	\$ 3370
XDT50 (Remote control)	Carbon Steel	260mm	3	220	730*430*500mm+ 1550*90*80mm	730*430*500mm+ 1550*90*80mm	136.5	\$ 3650
XDT50 (CNC version)	Carbon Steel	260mm	3	220	730*430*500mm+ 1550*90*80mm	730*430*500mm+ 1550*90*80mm	136.5	\$ 3780

Accessories of high-speed boring and welding machine (XDT50)

Accessories	Specifications	
Boring and welding head	Boring bar	$\phi 50 \text{ mm} * 1$
	Knife shaft	1.5 m *1/0.6 m*1
Supporting base	2	
Tile support	1	

Quality, price, time and service is the tenet of our business.

Credit, reposal, negotiation and cooperation is our standard.



ZHENGZHOU LERFORD MACHINERY EQUIPMENT CO.,LTD

Tel: 86 371 55960109

Fax: 86 371 55960109

Mobile:+8615838007835

Website:www.lffoodmachine.com

E-mail:susan@pelletmilling.com

Skype:annieshuang1129

Lock	1
Support bolt	8
Centering sleeve	4
Knife rest	1
Top plate	1
Oil can	1
Adjustable wrench	1
Socket screw hexagon wrench	1
Machine clamp blade	10*1
Machine clamp handle	φ 16 mm/ φ 12 mm
Top knife sleeve	1
Spare small screws	1
Wire feeding tube	2
Connecting wire for master welder	1
Welding torch rod	1.2 m*1/0.3 m*1
Centering sleeve	1
Shroud	3
Nozzle	3

Portable boring machine (XDT60):

Quality, price, time and service is the tenet of our business.

Credit, reposal, negotiation and cooperation is our standard.



ZHENGZHOU LERFORD MACHINERY EQUIPMENT CO.,LTD

Tel: 86 371 55960109

Fax: 86 371 55960109

Mobile:+8615838007835

Website:www.lffoodmachine.com

E-mail:susan@pelletmilling.com

Skype:annieshuang1129

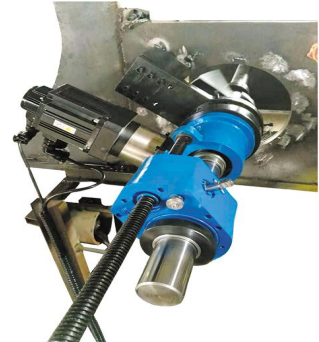

Model	Material	Capacity	Power	Voltage	Size	Packing Size	Weight	Price
XDT60 (standard)	Carbon Steel	420mm	2	220	800*800*730mm +2100*100*100mm	800*800*730mm +2100*100*100mm	221	\$ 6620
XDT60 (hydraulic)	Carbon Steel	420mm	2	220	800*800*730mm +2100*100*100mm	800*800*730mm +2100*100*100mm	290	\$ 19860
XDT60 (electric)	Carbon Steel	420mm	2	220	800*800*730mm +2100*100*100mm	800*800*730mm +2100*100*100mm	221	\$ 13870

Accessories of portable boring machine (XDT60)

Accessories	Specifications
Knife shaft	φ 60, 2 mm*1
Support	2
Centering device	1
Knife rest	3
Support bolt	8
Blade	1
Knife handle	1

Quality, price, time and service is the tenet of our business.

Credit, reposal, negotiation and cooperation is our standard.



ZHENGZHOU LERFORD MACHINERY EQUIPMENT CO.,LTD

Tel: 86 371 55960109
 Mobile:+8615838007835
 E-mail:susan@pelletmilling.com

Fax: 86 371 55960109
 Website:www.lffoodmachine.com
 Skype:annieshuang1129

Oil can	1
Adjustable wrench	1
Socket screw hexagon wrench	1

Portable boring machine (XDT90):

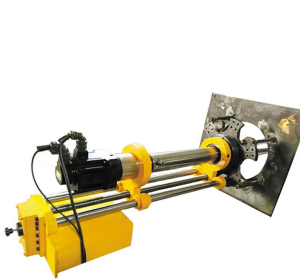

Model	Material	Capacity	Power	Voltage	Price
XDT90 (standard)	Carton Steel	500mm	3	220	\$ 12590
XDT90 (electric)	Carton Steel	500mm	3	220	\$ 22580
XDT90 (Hydraulics)	Carton Steel	500mm	3	220	\$ 28680

Accessories of portable boring machine (XDT90-1 and XDT90-2)

Specifications Accessories	XDT90-1	XDT90-2
	Boring bar	2 m*1
Auxiliary knife rest	4	
The knife	1	
Support	2	

Portable boring machine(XDT110):

Quality, price, time and service is the tenet of our business.
Credit, reposal, negotiation and cooperation is our standard.



ZHENGZHOU LERFORD MACHINERY EQUIPMENT CO.,LTD

Tel: 86 371 55960109
Mobile:+8615838007835
E-mail:susan@pelletmilling.com

Fax: 86 371 55960109
Website:www.lffoodmachine.com
Skype:annieshuang1129

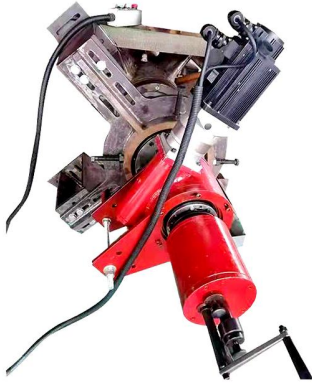

Model	Material	Capacity	Power	Voltage	Price
XDT110(electric)	Carton Steel	500mm	4.5	380	\$ 39980

Flange machine

We offer a full range of flange facing machine models, from hand-cranked to heavy-duty portable options. Our XDFC250 is a reliable Manual Flange Processing Machine, ideal for small-scale flange repair. The XDFC300, XDFC610, XDFC1000, XDFC2000, and XDFC4000 are powerful portable flange facing machine solutions, designed for on-site machining of large flanges without disassembly. All models are available as flange-facing-machine-for-sale, delivering precise facing and restoration for industrial flanges in construction, oil & gas, and marine applications.

FLANGE LATHE MACHINE



XDFC250-hand-cranked



XDFC300-Portable

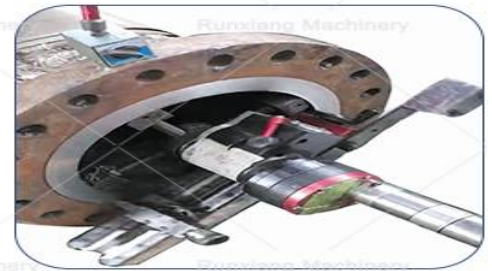

XDFC610-Portable



XDFC1000-Portable



XDFC2000-Portable



XDFC4000-Portable

Quality, price, time and service is the tenet of our business.
Credit, reposal, negotiation and cooperation is our standard.



ZHENGZHOU LERFORD MACHINERY EQUIPMENT CO.,LTD

Tel: 86 371 55960109

Fax: 86 371 55960109

Mobile:+8615838007835

Website:www.lffoodmachine.com

E-mail:susan@pelletmilling.com

Skype:annieshuang1129

Finished product

Our hand-cranked and portable flange facing machines deliver outstanding on-site restoration for damaged flanges:

1.Hand-cranked model: Repairs worn, uneven flange faces precisely, turning rough, pitted surfaces into smooth, dimensionally accurate finishes without disassembly.

2.Portable model: Efficiently handles corroded, rusted flanges, restoring sealing surfaces to like-new condition for heavy-duty industrial applications.

Both machines ensure reliable, high-precision flange repair, ideal for construction, oil & gas, and marine equipment maintenance.

Runxiang Machinery

Finished Product

Runxiang Machinery

Hand-cranked:



Before



After

Portable:



Before



After

**Quality, price, time and service is the tenet of our business.
Credit, reposal, negotiation and cooperation is our standard.**



ZHENGZHOU LERFORD MACHINERY EQUIPMENT CO.,LTD

Tel: 86 371 55960109
Mobile:+8615838007835
E-mail:susan@pelletmilling.com

Fax: 86 371 55960109
Website:www.lffoodmachine.com
Skype:annieshuang1129

Product Technical Information

Manual flange processing machine (XDFC250) :

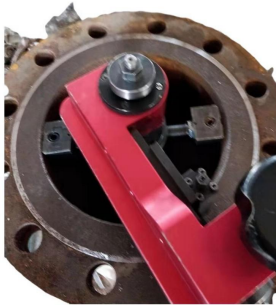

Model	Material	Processing range	Weight	Price
XDFC250	carbon steel	25.4-350mm	18	\$ 4411

Portable flange lathe (XDFC300) :

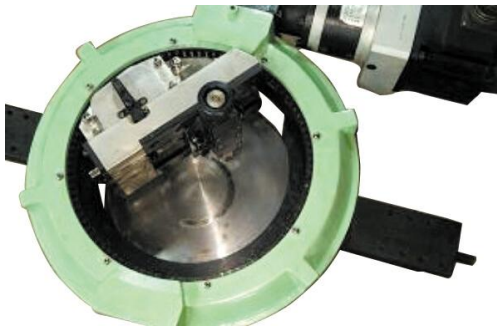

Model	Material	Capacity	Size	weight	Price
XDFC300 (electric)	carbon steel	300mm	1160*610*390mm	98	\$ 9926

Portable flange lathe(XDFC610):

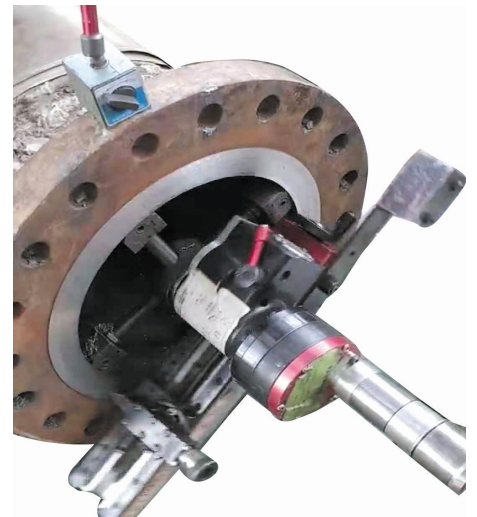

**Quality, price, time and service is the tenet of our business.
Credit, reposal, negotiation and cooperation is our standard.**



ZHENGZHOU LERFORD MACHINERY EQUIPMENT CO.,LTD

Tel: 86 371 55960109

Fax: 86 371 55960109

Mobile:+8615838007835

Website:www.lffoodmachine.com

E-mail:susan@pelletmilling.com

Skype:annieshuang1129

Model	Material	Capacity	Size	weight	Price
XDFC610 (electric)	carbon steel	610mm	1220*1120*390mm	305	\$ 12132

Portable flange lathe(XDFC1000):

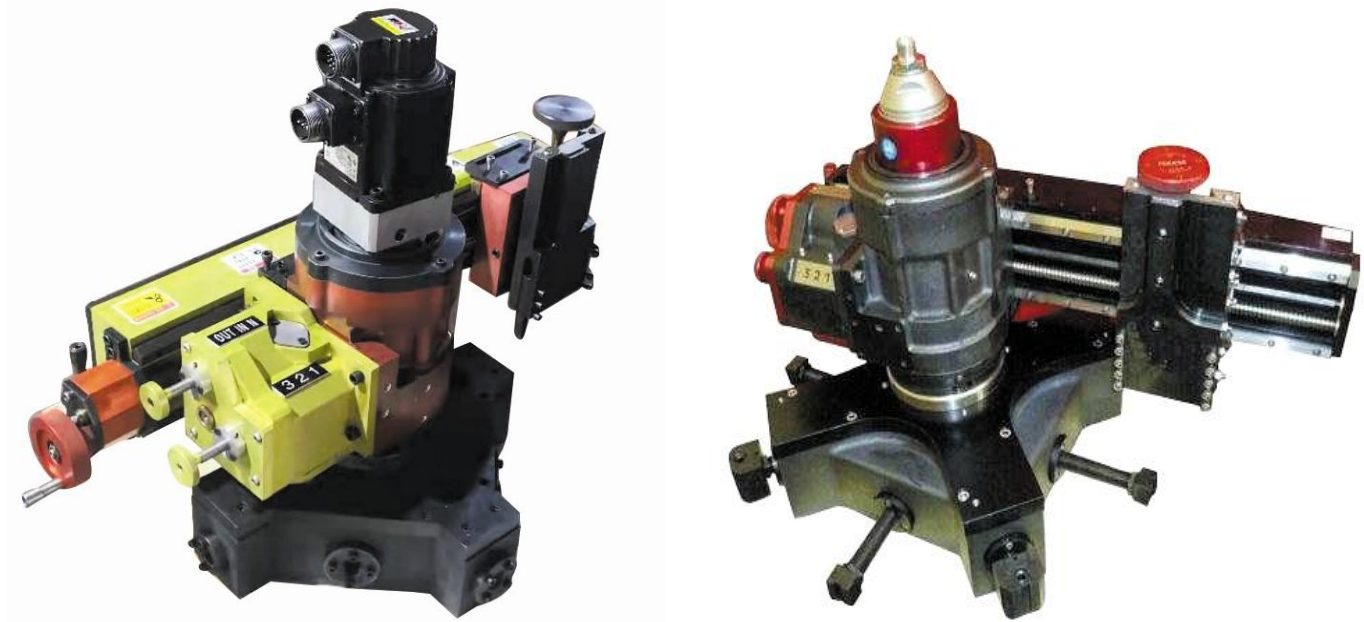

Model	Material	Capacity	Price
XDFC1000 (electric)	carbon steel	1000mm	\$ 19853

Portable flange lathe(XDFC2000):



Quality, price, time and service is the tenet of our business.
Credit, reposal, negotiation and cooperation is our standard.



ZHENGZHOU LERFORD MACHINERY EQUIPMENT CO.,LTD

Tel: 86 371 55960109

Fax: 86 371 55960109

Mobile:+8615838007835

Website:www.lffoodmachine.com

E-mail:susan@pelletmilling.com

Skype:annieshuang1129

Model	Power	Voltage	Material	Capacity	Price
XDFC2000 (electric)	2	220v	carbon steel	2000mm	\$ 39706

Portable flange lathe(XDFC4000):



Model	Power	Voltage	Material	Capacity	Price
XDFC4000 (electric)	4.5	220v	carbon steel	4000mm	\$ 77205

Milling machine

We offer a full range of portable milling machines for on-site industrial repair:

1.XDLWX2000 Portable CNC Thread Milling Machine: CNC-controlled precision for thread milling and precision machining.

2.XDDBX1000 Portable Single Arm Milling Machine: Compact single-arm design for flexible, small-scale milling tasks.

3.XDLMX1000 Portable Gantry Milling Machine: Sturdy gantry structure ideal for large-component surface milling and heavy-duty machining.

All models are portable, easy to operate, and perfect for restoring engineering machinery components without disassembly.

Quality, price, time and service is the tenet of our business.

Credit, reposal, negotiation and cooperation is our standard.



ZHENGZHOU LERFORD MACHINERY EQUIPMENT CO.,LTD

Tel: 86 371 55960109

Fax: 86 371 55960109

Mobile:+8615838007835

Website:www.lffoodmachine.com

E-mail:susan@pelletmilling.com

Skype:annieshuang1129

MILLING MACHINE

XDLWX2000-Portable CNC Thread Milling Machine



XDDBX1000-Portable Single Arm Milling Machine:



XDLMX1000-Portable Gantry Milling Machine:



Quality, price, time and service is the tenet of our business.
Credit, reposal, negotiation and cooperation is our standard.



ZHENGZHOU LERFORD MACHINERY EQUIPMENT CO.,LTD

Tel: 86 371 55960109

Fax: 86 371 55960109

Mobile:+8615838007835

Website:www.lffoodmachine.com

E-mail:susan@pelletmilling.com

Skype:annieshuang1129

Finished product

Our XDLWX2000 Portable CNC Thread Milling Machine and general Portable Milling Machine deliver exceptional on-site restoration for damaged components. The XDLWX2000 expertly repairs corroded, damaged threads, restoring precise engagement and functionality. Meanwhile, our standard Portable Milling Machine transforms worn, rusted, or uneven flange surfaces into smooth, pristine finishes. Both machines deliver professional, high-precision results to extend component lifespan, making them essential tools for industrial repair and maintenance.

Finished Product

XDLWX2000-Portable CNC Thread Milling Machine:



Before



After

Portable Milling Machine:



Before

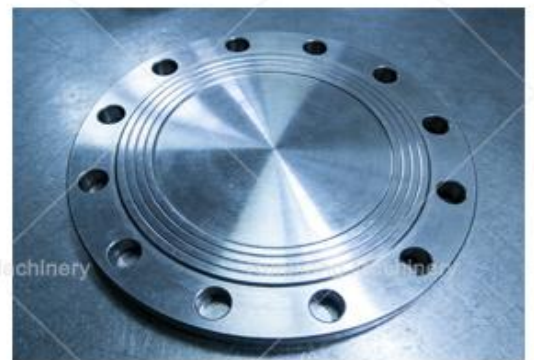

After

Product technical information

Quality, price, time and service is the tenet of our business.
Credit, reposal, negotiation and cooperation is our standard.



ZHENGZHOU LERFORD MACHINERY EQUIPMENT CO.,LTD

Tel: 86 371 55960109

Fax: 86 371 55960109

Mobile:+8615838007835

Website:www.lffoodmachine.com

E-mail:susan@pelletmilling.com

Skype:annieshuang1129

Portable CNC Thread Milling Machine(XDLWX2000):

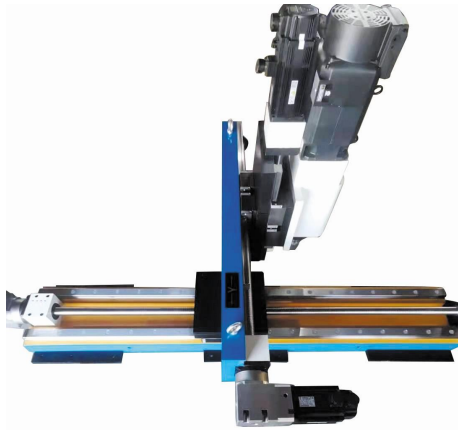

Model	Power	Voltage	Material	Capacity	Price
XDLWX2000	3.7	380v	carbon steel	2000mm	\$ 44117

Portable Single Arm Milling Machine(XDDBX1000):



Model	Power	Voltage	Material	Capacity	size	Price
XDDBX1000	3	380v	carbon steel	1000mm	2250*860*860mm	\$ 15441
XDDBX2000	3	380v	carbon steel	2000mm	29700*560*500mm+24500*640*900mm	\$ 22058
XDDBX3000	3	380v	carbon steel	3000mm		\$ 33088

Portable Gantry Milling Machine(XDLMX1000)

Quality, price, time and service is the tenet of our business.

Credit, reposal, negotiation and cooperation is our standard.



ZHENGZHOU LERFORD MACHINERY EQUIPMENT CO.,LTD

Tel: 86 371 55960109
 Mobile:+8615838007835
 E-mail:susan@pelletmilling.com

Fax: 86 371 55960109
 Website:www.lffoodmachine.com
 Skype:annieshuang1129

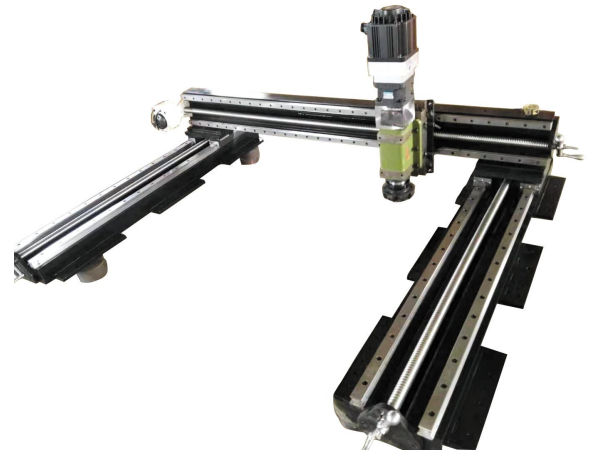

Model	Power	Voltage	Material	Capacity	Price
XDLMX1000	4.5	380v	carbon steel	1000mm	\$ 22058
XDLMX2000	4.5	380v	carbon steel	2000mm	\$ 35294
XDLMX3000	4.5	380v	carbon steel	3000mm	\$ 55147

Internal hole welding and shaft end machine

We offer a complete range of on-site repair machines for internal hole and shaft maintenance. Our Automatic Soldering Machine delivers precise inner hole welding to repair worn bores efficiently. For shaft repair, our XDZ300 and XDZ500 models are reliable Portable Shaft End Machine options, functioning as a portable shaft lathe and portable shaft turning lathe to restore shaft dimensions without disassembly. We also provide a matching sleeve pressing machine for complete component disassembly and reassembly, making our equipment ideal for heavy machinery, engineering, and industrial field maintenance.

INTERNAL HOLE WELDING AND SHAFT END LATHE

Automatic Soldering Machine:



XDZ300-Portable Shaft And Machine:



XDZ500-Portable Shaft And Machine



Quality, price, time and service is the tenet of our business.
Credit, reposal, negotiation and cooperation is our standard.



ZHENGZHOU LERFORD MACHINERY EQUIPMENT CO.,LTD

Tel: 86 371 55960109

Fax: 86 371 55960109

Mobile:+8615838007835

Website:www.lffoodmachine.com

E-mail:susan@pelletmilling.com

Skype:annieshuang1129

Finished product

Our Automatic Internal Hole Welding Machine and Portable Shaft End Lathe bring worn components back to like-new condition:

- 1. Automatic Internal Hole Welding Machine:** Repairs corroded, damaged inner bores, restoring precise, smooth surfaces for perfect bearing fit.
- 2. Portable Shaft End Lathe:** Restores pitted, worn shafts to precise dimensions, extending component service life.

These machines avoid costly part replacements and minimize downtime, ideal for on-site industrial maintenance.

Finished Product

Automatic Internal Hole Welding Machine:



Before



After

Portable Shaft End Lathe



Before



After

Quality, price, time and service is the tenet of our business.
Credit, reposal, negotiation and cooperation is our standard.



ZHENGZHOU LERFORD MACHINERY EQUIPMENT CO.,LTD

Tel: 86 371 55960109
 Mobile:+8615838007835
 E-mail:susan@pelletmilling.com

Fax: 86 371 55960109
 Website:www.lffoodmachine.com
 Skype:annieshuang1129

Product technical information

Automatic soldering machine



Model	Power	Voltage	Material	Capacity	Price
XHC250	100W	220v	carbon steel	250mm	\$ 1323
XHC500	100W	220v	carbon steel	500mm	\$ 1764

Welding Machine Accessories

Specifications	Automatic Inner Hole Welding
Accessories	
XDH250 nose	1
Wire feeding tube	1
Connecting wire for master welder	1
Shielding	3
Conductive mouth	3
Centering sleeve	1
1.2 m welding torch rod	1

Shaft-end lathes(XDZ300):

Quality, price, time and service is the tenet of our business.
Credit, reposal, negotiation and cooperation is our standard.



ZHENGZHOU LERFORD MACHINERY EQUIPMENT CO.,LTD

Tel: 86 371 55960109
 Mobile:+8615838007835
 E-mail:susan@pelletmilling.com

Fax: 86 371 55960109
 Website:www.lffoodmachine.com
 Skype:annieshuang1129

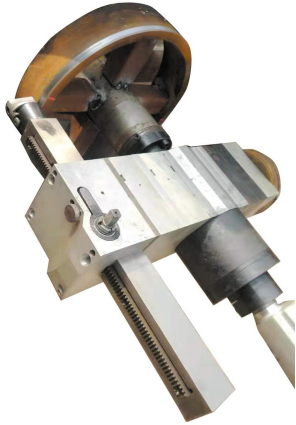

Model	Power	Voltage	Material	Capacity	Price
XDZ300(standard)	1.5	220v	carbon steel	300mm	\$ 6617
XDZ300(Extended)	1.5	220v	carbon steel	300mm	\$ 7720

Shaft-end lathes(XDZ500):

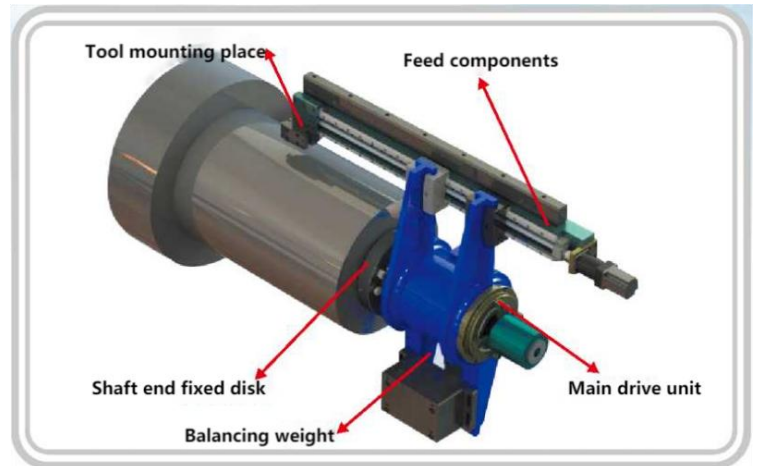

Model	Power	Voltage	Material	Capacity	Price
XDZ500(electric)	2	380v	carbon steel	500mm	\$ 11029

Hydraulic Equipment

We offer reliable hydraulic equipment for heavy machinery maintenance:

1.XDY70 Sleeve Pressing Machine: Available in manual and electric versions, this portable press is designed for installing and removing sleeves and bushings on-site, delivering strong hydraulic force for efficient disassembly and reassembly.

2.XDY100 Portable Chain Press: A robust hydraulic track pin press, ideal for disassembling and assembling excavator track chains. It's portable, easy to operate, and perfect for field repair of construction machinery components.

Both machines are durable, compact, and essential tools for on-site maintenance teams.

**Quality, price, time and service is the tenet of our business.
 Credit, reposal, negotiation and cooperation is our standard.**



HYDRAULIC EQUIPMENT

XDY70-Pressure Machine:



Manual version



Electric version

XDY100 Portable Chain Press:



Finished product

Our XDY70 Pressure Machine and XDY100 Portable Chain Press deliver powerful on-site maintenance for heavy machinery components:

1.XDY70 Pressure Machine: Efficiently removes and installs worn sleeves/bushings, restoring tight, precise fits to extend component lifespan.

2.XDY100 Portable Chain Press: Expertly disassembles and reassembles worn, muddy excavator track chains, returning them to clean, functional condition.



ZHENGZHOU LERFORD MACHINERY EQUIPMENT CO.,LTD

Tel: 86 371 55960109

Fax: 86 371 55960109

Mobile:+8615838007835

Website:www.lffoodmachine.com

E-mail:susan@pelletmilling.com

Skype:annieshuang1129

Both machines ensure reliable, damage-free repairs, making them essential tools for construction and mining equipment maintenance teams.

Runxiang Machinery

Finished Product

Runxiang Machinery

XDY70-Pressure Machine:



Before



After

XDY100-Portable Chain Press



Before



After

Product technical information



Quality, price, time and service is the tenet of our business.
Credit, reposal, negotiation and cooperation is our standard.



ZHENGZHOU LERFORD MACHINERY EQUIPMENT CO.,LTD

Tel: 86 371 55960109 Fax: 86 371 55960109
Mobile:+8615838007835 Website:www.lffoodmachine.com
E-mail:susan@pelletmilling.com Skype:annieshuang1129

XDY70Hand-cranked

XDY70Electric

XDY100

Model	Material	Capacity	Voltage	weight	Price
XDY70(Hand-cranked)	carbon steel	135mm		0.1t	\$ 661
XDY70 (Electric)	carbon steel	135mm	220v-380v	0.1t	\$ 772
XDY100	carbon steel	135mm	220v-380v	0.1t	\$ 992

Product Application

Our complete set of portable repair equipment is specifically designed for on-site repair scenarios in industries such as construction machinery, energy, shipbuilding, and mining. It enables high-precision repairs without disassembling large equipment:

- 1. For construction machinery repair:** After wear on the shaft holes and pin holes of excavators, loaders, and cranes, portable boring machines and integrated boring-welding machines are used for on-site welding and boring, quickly restoring component precision. Track link and pin disassembly is completed using portable chain pressing machines and sleeve pressing machines, avoiding the need for the entire machine to be returned to the factory.
- 2. For corrosion and damage to the sealing surfaces of pipeline flanges and valves in the oil and gas industry:** On-site milling using manual flange processing machines and portable flange lathes restores sealing performance. Critical shaft components are machined online using portable shaft end lathes.
- 3. For marine and marine engineering:** When the internal holes and threads of marine engines and deck machinery are damaged, portable CNC thread milling machines and automatic internal hole welding machines can operate inside the ship's hold, precisely repairing threads and holes, ensuring the ship's continued operation and safety.
- 4. In mining and heavy equipment:** large components of mining machinery and tunnel boring machines can be machined on-site at the mine after wear, significantly reducing downtime and lowering transportation and disassembly costs.
- 5. In power and energy equipment:** the shaft holes and flange faces of steam turbines and generators can be repaired using portable boring and welding machines and flange processing machines, enabling high-precision machining on-site at the power plant and avoiding the high costs and risks associated with disassembling and transporting the equipment.

Quality, price, time and service is the tenet of our business.
Credit, reposal, negotiation and cooperation is our standard.



ZHENGZHOU LERFORD MACHINERY EQUIPMENT CO.,LTD

Tel: 86 371 55960109
Mobile:+8615838007835
E-mail:susan@pelletmilling.com

Fax: 86 371 55960109
Website:www.lffoodmachine.com
Skype:annieshuang1129



Excavator Repair Solution

-Excavator Repair

This complete portable machinery lineup is your all-in-one answer to excavator maintenance, designed to restore damaged equipment to full operation without disassembly or factory return:

Step 1: Address Core Wear Issues

*Start with common excavator problems like damaged track chains, worn bushings, corroded bores, or stripped threads.

Step 2: Targeted Repair Process

*Use the chain press machine to safely disassemble worn track links and pins.

*Deploy the pressure machine to remove old bushings and install new ones, restoring tight, precise fits.

*Fix corroded/worn bores with the internal hole repair welding machine and portable boring machine, returning holes to exact dimensional tolerances.

*Repair worn shaft ends with the portable shaft end machine.

*Finish with the high-speed welding all-in-one machine for quick defect repairs, manual flange processing machine to restore sealing surfaces, and portable CNC thread milling machine to fix damaged threads.

Step 3: Return to Full Operation

*The excavator is fully restored to working condition, ready to get back to the job site.

-Key advantages of our products:

- 1. Minimize downtime:** On-site repairs can be completed within days, not weeks.
- 2. Reduce costs:** Extend component lifespan without replacing entire parts.
- 3. No disassembly required:** Repairs can be performed directly on the machine, avoiding costly disassembly and reassembly.
- 4. One-stop solution:** Covers all repair needs from track chains to flanges and threads.

Quality, price, time and service is the tenet of our business.
Credit, reposal, negotiation and cooperation is our standard.



ZHENGZHOU LERFORD MACHINERY EQUIPMENT CO.,LTD

Tel: 86 371 55960109

Fax: 86 371 55960109

Mobile:+8615838007835

Website:www.lffoodmachine.com

E-mail:susan@pelletmilling.com

Skype:annieshuang1129

EXCAVATOR USE



1.chain damage



2.chain press machine



3.Internal hole repair welding machine



6.Internal hole repair welding machine



5.pressure machine



4.Portable boring machine



7.Portable shaft end machine



8.high-speed welding all-in-one machine



9.Manual flange processing machine



11.complete



10.Portable CNC thread milling machine

Quality, price, time and service is the tenet of our business.
Credit, reposal, negotiation and cooperation is our standard.



ZHENGZHOU LERFORD MACHINERY EQUIPMENT CO.,LTD

Tel: 86 371 55960109

Fax: 86 371 55960109

Mobile:+8615838007835

Website:www.lffoodmachine.com

E-mail:susan@pelletmilling.com

Skype:annieshuang1129

Customer usage scenarios

Here are direct results from our customers using our portable machining equipment:

1.Agricultural Equipment Maintenance

Our machines excel at repairing tractor and farm machinery components. Customers report that our portable presses and boring equipment allow for quick on-site repairs of sleeves and bushings, eliminating the need to transport heavy equipment to a workshop. The result? Significantly reduced downtime and maintenance costs for farmers.

2.Industrial Flange & Pipe Restoration

Clients in the oil, gas, and water industries rely on our flange facing machines and thread milling equipment to repair damaged flanges and threads. They consistently praise the precision and smooth finish achieved after on-site machining, which restores the integrity of sealing surfaces and prevents leaks.

3.Reliable On-Site Precision

Across the board, customers appreciate the portability and accuracy of our tools. They confirm that our equipment delivers professional-grade results directly at the job site, leading to longer lifespan of components and substantial savings compared to replacing entire parts.

CUSTOMER USE



FAQ

1. Are these machines portable enough for on-site repairs?

Yes! All our machines are designed for maximum portability—they feature compact frames, lightweight

Quality, price, time and service is the tenet of our business.

Credit, reposal, negotiation and cooperation is our standard.



ZHENGZHOU LERFORD MACHINERY EQUIPMENT CO.,LTD

Tel: 86 371 55960109

Mobile:+8615838007835

E-mail:susan@pelletmilling.com

Fax: 86 371 55960109

Website:www.lffoodmachine.com

Skype:annieshuang1129

structures, and wheeled/hand-carry options. You can easily transport them to construction sites, farms, or industrial fields without needing to disassemble large equipment.

2. Can these machines repair different types of components?

Absolutely. Our product line covers a full range of repairs:

- 1) Portable boring & welding machines: Fix worn shaft holes, pin holes, and damaged bores
- 2) Flange processing machines: Restore corroded flange sealing surfaces
- 3) Thread milling & shaft end machines: Repair threads and worn shaft ends
- 4) Sleeve pressing & chain presses: Install/remove sleeves, bushings, and track chains

3. Do I need professional training to operate these machines?

No, our machines are built with user-friendly controls and simple setups. Most models come with intuitive operation panels and clear installation guides, so even on-site maintenance teams can quickly master them with basic training.

4. What industries are these machines suitable for?

They're widely used in construction machinery (excavators, loaders), agricultural equipment, oil & gas, marine, and mining industries—perfect for any scenario where on-site, non-disassembly repair is needed.

5. How do these machines reduce maintenance costs?

By enabling on-site precision repair, you avoid the high costs of transporting heavy equipment to workshops or replacing entire components. Our machines extend the lifespan of worn parts, cutting downtime and replacement expenses significantly

Product Packaging & Shipping

We offer global air freight express service (via DHL, FedEx, UPS, or TNT) for all portable industrial repair equipment, ensuring fast and safe delivery to your doorstep. Delivery typically takes 7-15 business days to most countries, and we provide all necessary customs documents (commercial invoice, packing list, certificate of origin) to assist with customs clearance. Production cycle is 7-20 business days, depending on the model and order quantity, allowing you to quickly obtain on-site repair equipment and minimize downtime.

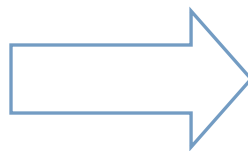

Quality, price, time and service is the tenet of our business.

Credit, reposal, negotiation and cooperation is our standard.



ZHENGZHOU LERFORD MACHINERY EQUIPMENT CO.,LTD

Tel: 86 371 55960109
Mobile:+8615838007835
E-mail:susan@pelletmilling.com

Fax: 86 371 55960109
Website:www.lffoodmachine.com
Skype:annieshuang1129

Company Introduction:

Zhengzhou Runxiang Machinery Equipment Co., Ltd. is an enterprise focusing on the research and development, production and sales of agricultural and food processing equipment. Over the years, it has been committed to providing customers with high-quality, high-performance equipment and perfect solutions. The company has a team of professional engineers, technicians and sales staff who have rich experience and expertise in their respective fields.

In terms of research and development, the company continues to invest a lot of resources, pays attention to the latest technology and market demand in the industry, and has established cooperative relations with many scientific research institutions and universities at home and abroad to jointly carry out technical research and product innovation. Through continuous efforts, the company has launched a series of advanced equipment with independent intellectual property rights.

In the production process, the company strictly follows the international quality management system, from the procurement of raw materials to the assembly and testing of products, every link is strictly controlled to ensure the stable and reliable quality of the products. The company has a modern production base and advanced production equipment, which can meet the customized needs of different customers for equipment.

COMPANY INTRODUCTION



**Quality, price, time and service is the tenet of our business.
Credit, reposal, negotiation and cooperation is our standard.**



ZHENGZHOU LERFORD MACHINERY EQUIPMENT CO.,LTD

Tel: 86 371 55960109
Mobile:+8615838007835
E-mail:susan@pelletmilling.com

Fax: 86 371 55960109
Website:www.lffoodmachine.com
Skype:annieshuang1129

How about after sales service:

After-sales service policy

1. After receiving payment from customers , sales should reconfirm the basic requirements of the machine configuration, voltage hertz, accessories and other basic requirements as soon as possible, and then send a purchase order to the workshop as soon as possible in order to save time of customers.
2. Make sure to keep the pictures before and after the packaging before shipping, and reconfirm whether the shipping list is consistent with the purchase order and the customer's needs.
3. After receiving the bill of lading, prepare the packing list and invoice for customs clearance and other customs clearance documents that the customer may need as soon as possible.
4. Every one week, two weeks and or one month (determined by the voyage), follow up the freight forwarder to check the latest route of the customer's cargo and inform the customer about the newest arrival time.
5. Please remind customers to bring customs clearance information to the freight forwarder to prepare for customs clearance ten days before the arrival of the goods.
6. Please contact customers in time to follow up the latest progress of customs clearance and transportation, remind customers to check whether the packaging is in good condition, and protect the packaging during transportation to avoid damage to the machine.
7. Must contact customers to guide the wire connection,using and precautions before and during operation.
8. After sales follow up must be provided every month, and any after-sales problems are reported and resolved in time. If the after-sales problems are not resolved as required, according to the seriousness of the circumstances, sales will be warned, punished, and expelled in accordance with the company's rules and regulations.

9.If you have any other useful suggestion about our after sales service,welcome to contact us at susan@pelletmilling.com any useful suggestion will get extra \$100 from our company as gift,welcome everyone!

How to use the machine?



Quality, price, time and service is the tenet of our business.
Credit, reposal, negotiation and cooperation is our standard.



ZHENGZHOU LERFORD MACHINERY EQUIPMENT CO.,LTD

Tel: 86 371 55960109
Mobile:+8615838007835
E-mail:susan@pelletmilling.com

Fax: 86 371 55960109
Website:www.lffoodmachine.com
Skype:annieshuang1129

How about the customer feedback?



RUNXIANG MACHINERY HAS COOPERATED WITH THE MINISTRY OF AGRICULTURE OF NIGERIA, THE MINISTRY OF AGRICULTURE OF GHANA, THE MINISTRY OF AGRICULTURE OF CONGO, THE NATIONAL DEVELOPMENT AND REFORM COMMISSION OF KENYA, THE JAMAICA OFFICE OF THE UNITED NATIONS CHARITY FEDERATION, THE MOROCCAN FOOD ASSOCIATION, THE NATIONAL STONE ADMINISTRATION OF COTE D'IVOIRE AND OTHER DOZENS OF NATIONAL PROCUREMENT PROJECTS. WE HAVE EXPORTED TO 158 COUNTRIES AND REGIONS IN THE WORLD.THERE HAVE 3 OVERSEAS WAREHOUSES AND OFFICES IN KENYA, MOROCCO AND NIGERIA. WELCOME TO VISIT AND DISCUSS!

OUR ADVANTAGES AND PROMISE:

- 1.TWO YEARS GUARANTEE WITH ALL OF OUR MACHINE(IT DOES NOT INCLUDE WEAR AND CONSUMABLE PARTS).
- 2.FREE ONLINE AFTER SALES SERVICE FOREVER.
- 3.ACCESSORIES ARE ALWAYS AVAILABLE.
- 4.OVERSEAS WAREHOUSE SPOT SERVICE IN KENYA, MOROCCO AND NIGERIA.
- 5.DDP DOOR-TO-DOOR SERVICE IN 98 COUNTRIES INCLUDING EUROPE, AMERICA, SOUTHEAST ASIA, THE MIDDLE EAST, AND AFRICA.
- 6.WE CAN CUSTOMIZE THE PRODUCTS AND VOLTAGES THAT CUSTOMERS NEED ACCORDING TO THEIR SPECIFIC NEEDS, AND CAN ACCEPT OEM.



03 QUALITY FIRST SERVICE FIRST

QUALITY FIRST SERVICE FIRST 04

Quality, price, time and service is the tenet of our business.
Credit, reposal, negotiation and cooperation is our standard.



ZHENGZHOU LERFORD MACHINERY EQUIPMENT CO.,LTD

Tel: 86 371 55960109
Mobile:+8615838007835
E-mail:susan@pelletmilling.com

Fax: 86 371 55960109
Website:www.lffoodmachine.com
Skype:annieshuang1129

Customer visits



Our Certification:

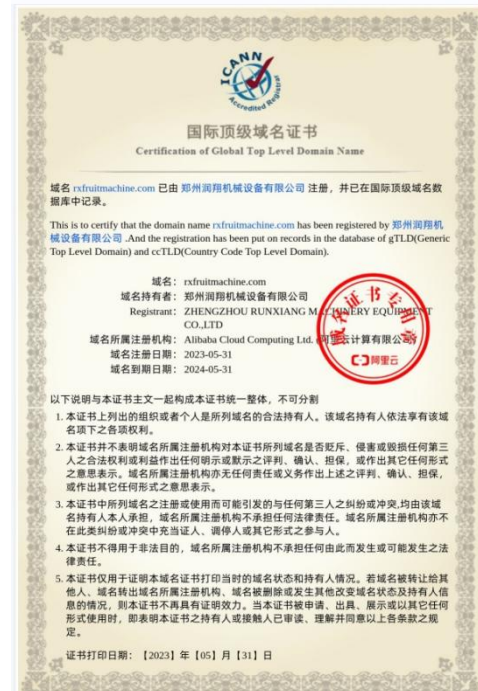

Quality, price, time and service is the tenet of our business.
Credit, reposal, negotiation and cooperation is our standard.



ZHENGZHOU LERFORD MACHINERY EQUIPMENT CO.,LTD

Tel: 86 371 55960109
Mobile:+8615838007835
E-mail:susan@pelletmilling.com

Fax: 86 371 55960109
Website:www.lffoodmachine.com
Skype:annieshuang1129

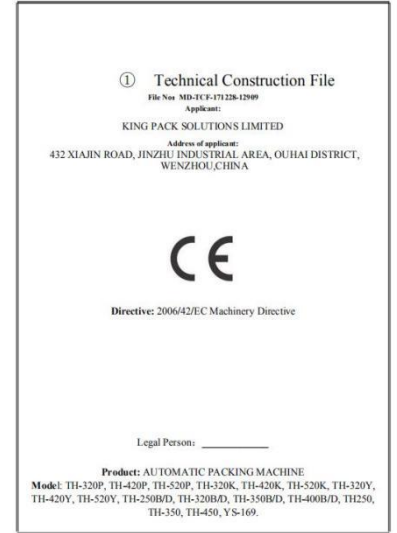

Remarks:

I.Delivery time: 15 days after receiving clients' prepayment.

II.Payment term: 50% as prepayment by T/T, the balance of 50% should be paid before seller send the machine.

III. Valid time: This quotation is valid for one month.

IV .Quality Guarantee Terms:

Quality guarantee term is for one year. Malfunctions which are caused by machine-self and quality will be responsible for our manufacturer. Other malfunctions which are caused by operation mistakes, man-made problems, etc will be responsible for clients-self.

Contact details:

Contact person: Miss Susan

Email:susan@pelletmilling.com

Whatsapp&Wechat:+86 15838007835

Website: www.rxpelletmachine.com

Address:No 41th,Jinsuo Road,Zhengzhou city,Henan province,China

**Quality, price, time and service is the tenet of our business.
Credit, reposal, negotiation and cooperation is our standard.**